

APPENDIX P

SIZING OF WATER PIPING SYSTEM

(Not Adopted by the State of Oregon)

(The provisions contained in this appendix are not mandatory unless specifically referenced in the adopting ordinance.)

SECTION AP101 GENERAL

AP101.1 Scope.

AP101.1.1 This appendix outlines two procedures for sizing a water piping system (see Sections AP103.3 and AP201.1). The design procedures are based on the minimum static pressure available from the supply source, the head charges in the system caused by friction and elevation, and the rates of flow necessary for operation of various fixtures.

AP101.1.2 Because of the variable conditions encountered in hydraulic design, it is impractical to specify definite and detailed rules for sizing of the water piping system. Accordingly, other sizing or design methods conforming to good engineering practice standards are acceptable alternatives to those presented herein.

SECTION AP102 INFORMATION REQUIRED

AP102.1 Preliminary. Obtain the necessary information regarding the minimum daily static service pressure in the area where the building is to be located. If the building supply is to be metered, obtain information regarding friction loss relative to the rate of flow for meters in the range of sizes likely to be used. Friction loss data can be obtained from most manufacturers of water meters.

AP102.2 Demand load.

AP102.2.1 Estimate the supply demand of the building main and the principal branches and risers of the system by totaling the corresponding demand from the applicable part of Table AP103.3(3).

AP102.2.2 Estimate continuous supply demands in gallons per minute (L/m) for lawn sprinklers, air conditioners, etc., and add the sum to the total demand for fixtures. The result is the estimated supply demand for the building supply.

SECTION AP103 SELECTION OF PIPE SIZE

AP103.1 General. Decide from Table P2903.1 what is the desirable minimum residual pressure that should be maintained at the highest fixture in the supply system. If the highest group of fixtures contains flush valves, the pressure for the group should not be less than 15 pounds per square inch (psi) (103.4 kPa) flowing. For flush tank supplies, the available pressure should not be less than 8 psi (55.2 kPa) flowing, except blowout action fixtures must not be less than 25 psi (172.4 kPa) flowing.

AP103.2 Pipe sizing.

AP103.2.1 Pipe sizes can be selected according to the following procedure or by other design methods conforming to acceptable engineering practice and *approved* by the administrative authority. The sizes selected must not be less than the minimum required by this code.

AP103.2.2 Water pipe sizing procedures are based on a system of pressure requirements and losses, the sum of which must not exceed the minimum pressure available at the supply source. These pressures are as follows:

1. Pressure required at fixture to produce required flow. See Sections P2903.1 of this code and Section 604.5 of the *International Plumbing Code*.
2. Static pressure loss or gain (due to head) is computed at 0.433 psi per foot (9.8 kPa/m) of elevation change.

Example: Assume that the highest fixture supply outlet is 20 feet (6096 mm) above or below the supply source. This produces a static pressure differential of 8.66 psi (59.8 kPa) loss [20 feet by 0.433 psi/foot (2096 mm by 9.8 kPa/m)].

3. Loss through water meter. The friction or pressure loss can be obtained from meter manufacturers.
4. Loss through taps in water main.
5. Losses through special devices such as filters, softeners, backflow prevention devices and pressure regulators. These values must be obtained from the manufacturers.
6. Loss through valves and fittings. Losses for these items are calculated by converting to *equivalent length* of piping and adding to the total pipe length.
7. Loss caused by pipe friction can be calculated when the pipe size, the pipe length and the flow through the pipe are known. With these three items, the friction loss can be determined. For piping flow charts not included, use manufacturers' tables and velocity recommendations.

Note: For all examples, the following metric conversions are applicable:

- 1 cubic foot per minute = 0.4719 L/s
- 1 square foot = 0.0929 m²
- 1 degree = 0.0175 rad
- 1 pound per square inch = 6.895 kPa
- 1 inch = 25.4 mm
- 1 foot = 304.8 mm
- 1 gallon per minute = 3.785 L/m

AP103.3 Segmented loss method. The size of water service mains, branch mains and risers by the segmented loss method, must be determined according to water supply demand [gpm (L/m)], available water pressure [psi (kPa)] and friction loss caused by the water meter and *developed length* of pipe [feet (m)], including *equivalent length* of fittings. This design procedure is based on the following parameters:

- The calculated friction loss through each length of the pipe.
- A system of pressure losses, the sum of which must not exceed the minimum pressure available at the street main or other source of supply.
- Pipe sizing based on estimated peak demand, total pressure losses caused by difference in elevation, equipment, *developed length* and pressure required at the most remote fixture, loss through taps in water main, losses through fittings, filters, backflow prevention devices, valves and pipe friction.

Because of the variable conditions encountered in hydraulic design, it is impractical to specify definite and detailed rules for sizing of the water piping system. Current sizing methods do not address the differences in the probability of use and flow characteristics of fixtures between types of occupancies. Creating an exact model of predicting the demand for a building is impossible and final studies assessing the impact of water conservation on demand are not yet complete. The following steps are necessary for the segmented loss method.

1. **Preliminary.** Obtain the necessary information regarding the minimum daily static service pressure in the area where the building is to be located. If the building supply is to be metered, obtain information regarding friction loss relative to the rate of flow for meters in the range of sizes to be used. Friction loss data can be obtained from manufacturers of water meters. Enough pressure must be available to overcome all system losses caused by friction and elevation so that plumbing fixtures operate properly. Section 604.6 of the *International Plumbing Code* requires that the water distribution system be designed for the minimum pressure available taking into consideration pressure fluctuations. The lowest pressure must be selected to guarantee a continuous, adequate supply of water. The lowest pressure in the public main usually occurs in the summer because of lawn sprinkling and supplying water for air-conditioning cooling towers. Future demands placed on the public main as a result of large growth or expansion should also be considered. The available pressure will decrease as additional loads are placed on the public system.
2. **Demand load.** Estimate the supply demand of the building main and the principal branches and risers of the system by totaling the corresponding demand from the applicable part of Table AP103.3(3). When estimating peak demand, sizing methods typically use water supply fixture units (w.s.f.u.) [see Table AP103.3(2)]. This numerical factor measures the load-producing effect of a single plumbing fixture of a given kind. The use of fixture units can be applied to a single basic probability curve (or table), found in the various sizing methods

[Table AP103.3(3)]. The fixture units are then converted into gallons per minute (L/m) flow rate for estimating demand.

- 2.1. Estimate continuous supply demand in gallons per minute (L/m) for lawn sprinklers, air conditioners, etc., and add the sum to the total demand for fixtures. The result is the estimated supply demand for the building supply. Fixture units cannot be applied to constant-use fixtures such as hose bibbs, lawn sprinklers and air conditioners. These types of fixtures must be assigned the gallon per minute (L/m) value.
3. **Selection of pipe size.** This water pipe sizing procedure is based on a system of pressure requirements and losses, the sum of which must not exceed the minimum pressure available at the supply source. These pressures are as follows:
 - 3.1. Pressure required at the fixture to produce required flow. See Section P2903.1 of this code and Section 604.5 of the *International Plumbing Code*.
 - 3.2. Static pressure loss or gain (because of head) is computed at 0.433 psi per foot (9.8 kPa/m) of elevation change.
 - 3.3. Loss through a water meter. The friction or pressure loss can be obtained from the manufacturer.
 - 3.4. Loss through taps in water main [see Table AP103.3(4)].
 - 3.5. Losses through special devices such as filters, softeners, backflow prevention devices and pressure regulators. These values must be obtained from the manufacturers.
 - 3.6. Loss through valves and fittings [see Tables AP103.3(5) and AP103.3(6)]. Losses for these items are calculated by converting to *equivalent length* of piping and adding to the total pipe length.
 - 3.7. Loss caused by pipe friction can be calculated when the pipe size, the pipe length and the flow through the pipe are known. With these three items, the friction loss can be determined using Figures AP103.3(2) through AP103.3(7). When using charts, use pipe inside diameters. For piping flow charts not included, use manufacturers' tables and velocity recommendations. Before attempting to size any water supply system, it is necessary to gather preliminary information which includes available pressure, piping material, select design velocity, elevation differences and *developed length* to most remote fixture. The water supply system is divided into sections at major changes in elevation or where branches lead to fixture groups. The peak demand must be determined in each part of the hot and cold water supply system which includes the corresponding water supply fixture unit and conversion to gallons per minute (L/m) flow rate to be expected

through each section. Sizing methods require determination of the “most hydraulically remote” fixture to compute the pressure loss caused by pipe and fittings. The hydraulically remote fixture represents the most downstream fixture along the circuit of piping requiring the most available pressure to operate properly. Consideration must be given to all pressure demands and losses, such as friction caused by pipe, fittings and equipment; elevation; and the residual pressure required by Table P2903.1. The two most common and frequent complaints about water supply system operation are lack of adequate pressure and noise.

Problem: What size Type L copper water pipe, service and distribution will be required to serve a two-story factory building having on each floor, back-to-back, two toilet rooms each equipped with hot and cold water? The highest fixture is 21 feet (6401 mm) above the street main, which is tapped with a 2-inch (51 mm) corporation cock at which point the minimum pressure is 55 psi (379.2 kPa). In the building basement, a 2-inch (51 mm) meter with a maximum pressure drop of 11 psi (75.8 kPa) and 3-inch (76 mm) reduced pressure principle backflow preventer with a maximum pressure drop of 9 psi (62.1 kPa) are to be installed. The system is shown by Figure AP103.3(1). To be determined are the pipe sizes for the service main and the cold and hot water distribution pipes.

Solution: A tabular arrangement such as shown in Table AP103.3(1) should first be constructed. The steps to be followed are indicated by the tabular arrangement itself as they are in sequence, columns 1 through 10 and lines A through L.

Step 1

Columns 1 and 2: Divide the system into sections breaking at major changes in elevation or where branches lead to fixture groups. After point B [see Figure AP103.3(1)], separate consideration will be given to the hot and cold water piping. Enter the sections to be considered in the service and cold water piping in Column 1 of the tabular arrangement. Column 1 of Table AP103.3(1) provides a line-by-line recommended tabular arrangement for use in solving pipe sizing.

The objective in designing the water supply system is to ensure an adequate water supply and pressure to all fixtures and equipment. Column 2 provides the pounds per square inch (psi) to be considered separately from the minimum pressure available at the main. Losses to take into consideration are the following: the differences in elevations between the water supply source and the highest water supply outlet, meter pressure losses, the tap in main loss, special fixture devices such as water softeners and backflow prevention devices and the pressure required at the most remote fixture outlet.

The difference in elevation can result in an increase or decrease in available pressure at the main. Where the water supply outlet is located above the source, this results in a loss in the available pressure and is subtracted from the pressure at the water source. Where the highest water supply outlet is located below the water supply source, there will be

an increase in pressure that is added to the available pressure of the water source.

Column 3: According to Table AP103.3(3), determine the gpm (L/m) of flow to be expected in each section of the system. These flows range from 28.6 to 108 gpm. Load values for fixtures must be determined as water supply fixture units and then converted to a gallon-per-minute (gpm) rating to determine peak demand. When calculating peak demands, the water supply fixture units are added and then converted to the gallon-per-minute rating. For continuous flow fixtures such as hose bibbs and lawn sprinkler systems, add the gallon-per-minute demand to the intermittent demand of fixtures. For example, a total of 120 water supply fixture units is converted to a demand of 48 gallons per minute. Two hose bibbs \times 5 gpm demand = 10 gpm. Total gpm rating = 48.0 gpm + 10 gpm = 58.0 gpm demand.

Step 2

Line A: Enter the minimum pressure available at the main source of supply in Column 2. This is 55 psi (379.2 kPa). The local water authorities generally keep records of pressures at different times of day and year. The available pressure can also be checked from nearby buildings or from fire department hydrant checks.

Line B: Determine from Table P2903.1 the highest pressure required for the fixtures on the system, which is 15 psi (103.4 kPa), to operate a flushometer valve. The most remote fixture outlet is necessary to compute the pressure loss caused by pipe and fittings, and represents the most downstream fixture along the circuit of piping requiring the available pressure to operate properly as indicated by Table P2903.1.

Line C: Determine the pressure loss for the meter size given or assumed. The total water flow from the main through the service as determined in Step 1 will serve to aid in the meter selected. There are three common types of water meters; the pressure losses are determined by the American Water Works Association Standards for displacement type, compound type and turbine type. The maximum pressure loss of such devices takes into consideration the meter size, safe operating capacity (gpm) and maximum rates for continuous operations (gpm). Typically, equipment imparts greater pressure losses than piping.

Line D: Select from Table AP103.3(4) and enter the pressure loss for the tap size given or assumed. The loss of pressure through taps and tees in pounds per square inch (psi) is based on the total gallon-per-minute flow rate and size of the tap.

Line E: Determine the difference in elevation between the main and source of supply and the highest fixture on the system. Multiply this figure, expressed in feet, by 0.43 psi (2.9 kPa). Enter the resulting psi loss on Line E. The difference in elevation between the water supply source and the highest water supply outlet has a significant impact on the sizing of the water supply system. The difference in elevation usually results in a loss in the available pressure because the water supply outlet is generally located above the water supply source. The loss is caused by the pressure required to lift the

water to the outlet. The pressure loss is subtracted from the pressure at the water source. Where the highest water supply outlet is located below the water source, there will be an increase in pressure which is added to the available pressure of the water source.

Lines F, G and H: The pressure losses through filters, backflow prevention devices or other special fixtures must be obtained from the manufacturer or estimated and entered on these lines. Equipment such as backflow prevention devices, check valves, water softeners, instantaneous or tankless water heaters, filters and strainers can impart a much greater pressure loss than the piping. The pressure losses can range from 8 psi to 30 psi.

Step 3

Line I: The sum of the pressure requirements and losses that affect the overall system (Lines B through H) is entered on this line. Summarizing the steps, all of the system losses are subtracted from the minimum water pressure. The remainder is the pressure available for friction, defined as the energy available to push the water through the pipes to each fixture. This force can be used as an average pressure loss, as long as the pressure available for friction is not exceeded. Saving a certain amount for available water supply pressures as an area incurs growth, or because of aging of the pipe or equipment added to the system is recommended.

Step 4

Line J: Subtract Line I from Line A. This gives the pressure that remains available from overcoming friction losses in the system. This figure is a guide to the pipe size that is chosen for each section, incorporating the total friction losses to the most remote outlet (measured length is called *developed length*).

Exception: When the main is above the highest fixture, the resulting psi must be considered a pressure gain (static head gain) and omitted from the sums of Lines B through H and added to Line J.

The maximum friction head loss that can be tolerated in the system during peak demand is the difference between the static pressure at the highest and most remote outlet at no-flow conditions and the minimum flow pressure required at that outlet. If the losses are within the required limits, every run of pipe will also be within the required friction head loss. Static pressure loss is at the most remote outlet in feet \times 0.433 = loss in psi caused by elevation differences.

Step 5

Column 4: Enter the length of each section from the main to the most remote outlet (at Point E). Divide the water supply system into sections breaking at major changes in elevation or where branches lead to fixture groups.

Step 6

Column 5: When selecting a trial pipe size, the length from the water service or meter to the most remote fixture outlet must be measured to determine the *developed length*. However, in systems having a flush valve or temperature controlled shower at the topmost floors the *developed length* would be from the water meter to the most remote flush valve on the system. A rule of thumb is that size will become progressively smaller as the system extends farther from the main source of supply. Trial pipe size may be arrived at by the following formula:

Line J: (Pressure available to overcome pipe friction) \times 100/*equivalent length* of run total *developed length* to most remote fixture \times percentage factor of 1.5 (note: a percentage factor is used only as an estimate for friction losses imposed for fittings for initial trial pipe size) = psi (average pressure drop per 100 feet of pipe).

For trial pipe size see Figure AP103.3(3) (Type L copper) based on 2.77 psi and 108 gpm = 2 $\frac{1}{2}$ inches. To determine the *equivalent length* of run to the most remote outlet, the *developed length* is determined and added to the friction losses for fittings and valves. The *developed lengths* of the designated pipe sections are as follows:

A - B	54 ft
B - C	8 ft
C - D	13 ft
D - E	150 ft

Total *developed length* = 225 ft

The *equivalent length* of the friction loss in fittings and valves must be added to the *developed length* (most remote outlet). Where the size of fittings and valves is not known, the added friction loss should be approximated. A general rule that has been used is to add 50 percent of the *developed length* to allow for fittings and valves. For example, the *equivalent length* of run equals the *developed length* of run (225 ft \times 1.5 = 338 ft). The total *equivalent length* of run for determining a trial pipe size is 338 feet.

Example: 9.36 (pressure available to overcome pipe friction) \times 100/338 (*equivalent length* of run = 225 \times 1.5) = 2.77 psi (average pressure drop per 100 feet of pipe).

Step 7

Column 6: Select from Table AP103.3(6) the *equivalent lengths* for the trial pipe size of fittings and valves on each pipe section. Enter the sum for each section in Column 6. (The number of fittings to be used in this example must be an estimate.) The *equivalent length* of piping is the *developed length* plus the *equivalent lengths* of pipe corresponding to friction head losses for fittings and valves. Where the size of fittings and valves is not known, the added friction head losses must be approximated. An estimate for this example is found in Table AP.1.

Step 8

Column 7: Add the figures from Column 4 and Column 6, and enter in Column 7. Express the sum in hundreds of feet.

Step 9

Column 8: Select from Figure AP103.3(3) the friction loss per 100 feet (30 480 mm) of pipe for the gallon-per-minute flow in a section (Column 3) and trial pipe size (Column 5). Maximum friction head loss per 100 feet is determined on the basis of total pressure available for friction head loss and the longest *equivalent length* of run. The selection is based on the gallon-per-minute demand, the uniform friction head loss, and the maximum design velocity. Where the size indicated by the hydraulic table indicates a velocity in excess of the selected velocity, a size must be selected which produces the required velocity.

Step 10

Column 9: Multiply the figures in Columns 7 and 8 for each section and enter in Column 9.

Total friction loss is determined by multiplying the friction loss per 100 feet (30 480 mm) for each pipe section in the total *developed length* by the pressure loss in fittings expressed as *equivalent length* in feet. Note: Section C-F should be considered in the total pipe friction losses only if greater loss occurs in Section C-F than in pipe Section D-E. Section C-F is not considered in the total *developed length*. Total friction loss in *equivalent length* is determined in Table AP.2.

Step 11

Line K: Enter the sum of the values in Column 9. The value is the total friction loss in *equivalent length* for each designated pipe section.

Step 12

Line L: Subtract Line J from Line K and enter in Column 10.

The result should always be a positive or plus figure. If it is not, repeat the operation using Columns 5, 6, 8 and 9 until a balance or near balance is obtained. If the difference between Lines J and K is a high positive number, it is an indication that the pipe sizes are too large and should be reduced, thus saving materials. In such a case, the operations using Columns 5, 6, 8 and 9 should be repeated.

The total friction losses are determined and subtracted from the pressure available to overcome pipe friction for trial pipe size. This number is critical because it provides a guide to whether the pipe size selected is too large and the process should be repeated to obtain an economically designed system.

Answer: The final figures entered in Column 5 become the design pipe size for the respective sections. Repeating this operation a second time using the same sketch but considering the demand for hot water, it is possible to size the hot water distribution piping. This has been worked up as a part of the overall problem in the tabular arrangement used for sizing the service and water distribution piping. Note that consideration must be given to the pressure losses from the street main to the water heater (Section A-B) in determining the hot water pipe sizes.

TABLE AP.1

COLD WATER PIPE SECTION	FITTINGS/VALVES	PRESSURE LOSS EXPRESSED AS EQUIVALENT LENGTH OF TUBE (feet)	HOT WATER PIPE SECTION	FITTINGS/VALVES	PRESSURE LOSS EXPRESSED AS EQUIVALENT OF TUBE (feet)
A-B	3-2 1/2" Gate valves	3	A-B	3-2 1/2" Gate valves	3
	1-2 1/2" Side branch tee	12	—	1-2 1/2" Side branch tee	12
B-C	1-2 1/2" Straight run tee	0.5	B-C	1-2" Straight run tee	7
	—	—	—	1-2" 90-degree ell	0.5
C-F	1-2 1/2" Side branch tee	12	C-F	1-1 1/2" Side branch tee	7
C-D	1-2 1/2" 90-degree ell	7	C-D	1-1 1/2" 90-degree ell	4
D-E	1-2 1/2" Side branch tee	12	D-E	1-1 1/2" Side branch tee	7

TABLE AP.2

PIPE SECTIONS	FRICTION LOSS EQUIVALENT LENGTH (feet)	
	Cold Water	Hot Water
A-B	0.69 × 3.2 = 2.21	0.69 × 3.2 = 2.21
B-C	0.085 × 3.1 = 0.26	0.16 × 1.4 = 0.22
C-D	0.20 × 1.9 = 0.38	0.17 × 3.2 = 0.54
D-E	1.62 × 1.9 = 3.08	1.57 × 3.2 = 5.02
Total pipe friction losses (Line K)	5.93	7.99

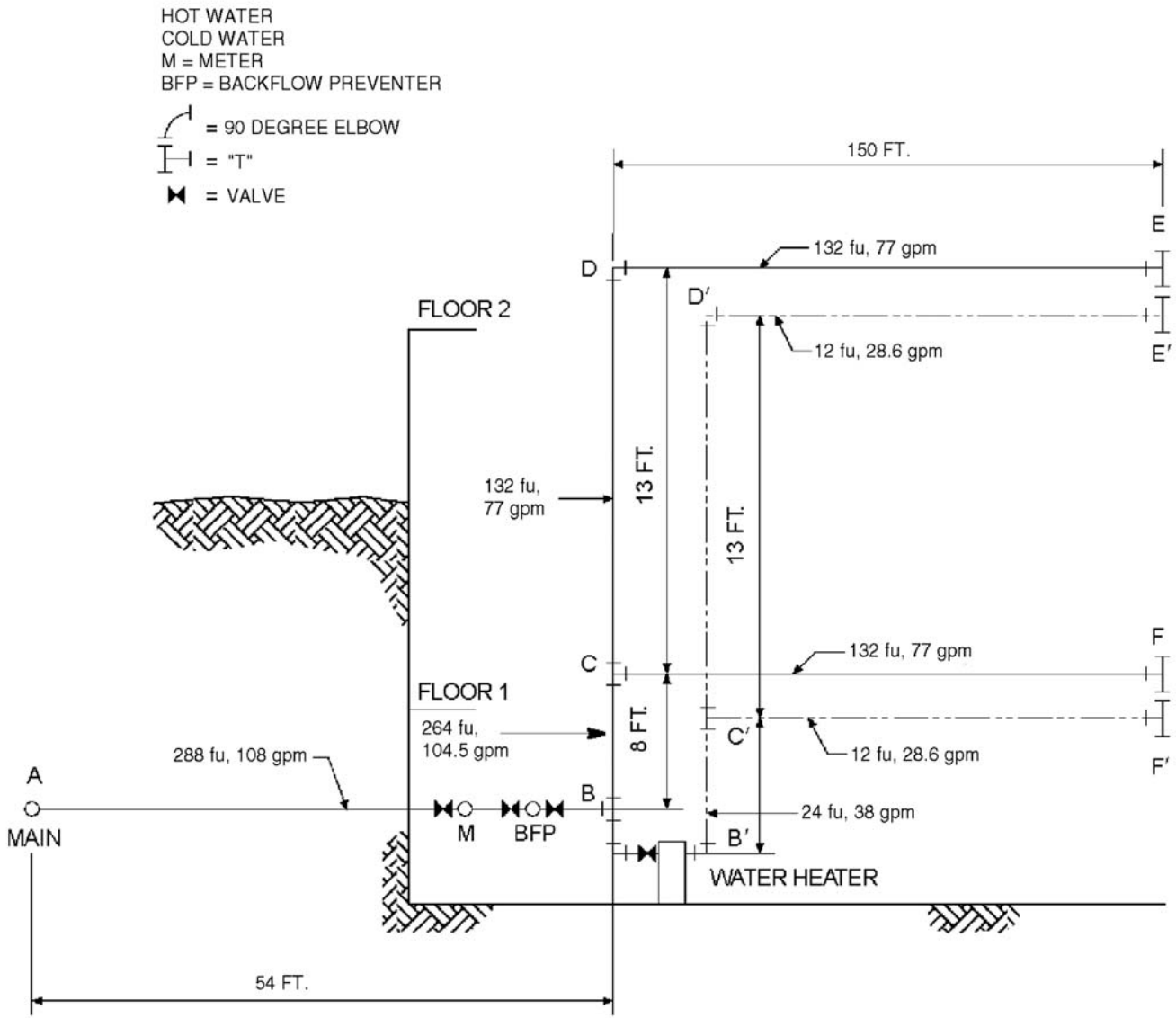

For SI: 1 foot = 304.8 mm, 1 gpm = 3.785 L/m.

FIGURE AP103.3(1)
 EXAMPLE-SIZING

**TABLE AP103.3(1)
RECOMMENDED TABULAR ARRANGEMENT FOR USE IN SOLVING PIPE SIZING PROBLEMS**

COLUMN	1		2	3	4	5	6	7	8	9	10
Line	Description		Lb per square inch (psi)	Gal. per min through section	Length of section (feet)	Trial pipe size (inches)	Equivalent length of fittings and valves (feet)	Total equivalent length col. 4 and col. 6 (100 feet)	Friction loss per 100 feet of trial size pipe (psi)	Friction loss in equivalent length col. 8 x col. 7 (psi)	Excess pressure over friction losses (psi)
A	Service and cold water distribution piping ^a	Minimum pressure available at main . . .	55.00								
B		Highest pressure required at a fixture (Table P2903.1)	15.00								
C		Meter loss 2" meter	11.00								
D		Tap in main loss 2" tap [Table AP103.3(4)]	1.61								
E		Static head loss 21 ft x 0.43 psi/ft.	9.03								
F		Special fixture loss backflow preventer	9.00								
G		Special fixture loss—Filter	0.00								
H		Special fixture loss—Other	0.00								
I		Total overall losses and requirements (Sum of Lines B through H)	45.64								
J		Pressure available to overcome pipe friction (Line A minus Line I)	9.36								
		FU									
	DESIGNATION	AB	288	108.0	54	2 1/2	15.00	0.69	3.2	2.21	—
	Pipe section (from diagram)	BC	264	104.5	8	2 1/2	0.5	0.85	3.1	0.26	—
	Cold water	CD	132	77.0	13	2 1/2	7.00	0.20	1.9	0.38	—
	Distribution piping	CF ^b	132	77.0	150	2 1/2	12.00	1.62	1.9	3.08	—
		DE ^b	132	77.0	150	2 1/2	12.00	1.62	1.9	3.08	—
K	Total pipe friction losses (cold)			—	—	—	—	—	—	5.93	—
L	Difference (Line J minus Line K)			—	—	—	—	—	—	—	3.43
	Pipe section (from diagram)	A'B'	288	108.0	54	2 1/2	12.00	0.69	3.3	2.21	—
	Diagram	B'C'	24	38.0	8	2	7.5	0.16	1.4	0.22	—
	Hot water	C'D'	12	28.6	13	1 1/2	4.0	0.17	3.2	0.54	—
	Distribution	C'F ^b	12	28.6	150	1 1/2	7.00	1.57	3.2	5.02	—
	Piping	D'E ^b	12	28.6	150	1 1/2	7.00	1.57	3.2	5.02	—
K	Total pipe friction losses (hot)			—	—	—	—	—	—	7.99	—
L	Difference (Line J minus Line K)			—	—	—	—	—	—	—	1.37

For SI: 1 inch = 25.4 mm, 1 foot = 304.8 mm, 1 psi = 6.895 kPa, 1 gpm = 3.785 L/m.

a. To be considered as pressure gain for fixtures below main (to consider separately, omit from "I" and add to "J").

b. To consider separately, in K use C-F only if greater loss than above.

**TABLE AP103.3(2)
LOAD VALUES ASSIGNED TO FIXTURES^a**

FIXTURE	OCCUPANCY	TYPE OF SUPPLY CONTROL	LOAD VALUES, IN WATER SUPPLY FIXTURE UNITS (wsfu)		
			Cold	Hot	Total
Bathroom group	Private	Flush tank	2.7	1.5	3.6
Bathroom group	Private	Flush valve	6.0	3.0	8.0
Bath tub	Private	Faucet	1.0	1.0	1.4
Bath tub	Public	Faucet	3.0	3.0	4.0
Bidet	Private	Faucet	1.5	1.5	2.0
Combination fixture	Private	Faucet	2.25	2.25	3.0
Dishwashing machine	Private	Automatic	—	1.4	1.4
Drinking fountain	Offices, etc.	$\frac{3}{8}$ " valve	0.25	—	0.25
Kitchen sink	Private	Faucet	1.0	1.0	1.4
Kitchen sink	Hotel, restaurant	Faucet	3.0	3.0	4.0
Laundry trays (1 to 3)	Private	Faucet	1.0	1.0	1.4
Lavatory	Private	Faucet	0.5	0.5	0.7
Lavatory	Public	Faucet	1.5	1.5	2.0
Service sink	Offices, etc.	Faucet	2.25	2.25	3.0
Shower head	Public	Mixing valve	3.0	3.0	4.0
Shower head	Private	Mixing valve	1.0	1.0	1.4
Urinal	Public	1" flush valve	10.0	—	10.0
Urinal	Public	$\frac{3}{4}$ " flush valve	5.0	—	5.0
Urinal	Public	Flush tank	3.0	—	3.0
Washing machine (8 lb)	Private	Automatic	1.0	1.0	1.4
Washing machine (8 lb)	Public	Automatic	2.25	2.25	3.0
Washing machine (15 lb)	Public	Automatic	3.0	3.0	4.0
Water closet	Private	Flush valve	6.0	—	6.0
Water closet	Private	Flush tank	2.2	—	2.2
Water closet	Public	Flush valve	10.0	—	10.0
Water closet	Public	Flush tank	5.0	—	5.0
Water closet	Public or private	Flushometer tank	2.0	—	2.0

For SI: 1 inch = 25.4 mm, 1 pound = 0.454 kg.

- a. For fixtures not listed, loads should be assumed by comparing the fixture to one listed using water in similar quantities and at similar rates. The assigned loads for fixtures with both hot and cold water supplies are given for separate hot and cold water loads and for total load. The separate hot and cold water loads being three-fourths of the total load for the fixture in each case.

**TABLE AP103.3(3)
TABLE FOR ESTIMATING DEMAND**

SUPPLY SYSTEMS PREDOMINANTLY FOR FLUSH TANKS			SUPPLY SYSTEMS PREDOMINANTLY FOR FLUSH VALVES		
Load	Demand		Load	Demand	
(Water supply fixture units)	(Gallons per minute)	(Cubic feet per minute)	(Water supply fixture units)	(Gallons per minute)	(Cubic feet per minute)
1	3.0	0.04104	—	—	—
2	5.0	0.0684	—	—	—
3	6.5	0.86892	—	—	—
4	8.0	1.06944	—	—	—
5	9.4	1.256592	5	15.0	2.0052
6	10.7	1.430376	6	17.4	2.326032
7	11.8	1.577424	7	19.8	2.646364
8	12.8	1.711104	8	22.2	2.967696
9	13.7	1.831416	9	24.6	3.288528
10	14.6	1.951728	10	27.0	3.60936
11	15.4	2.058672	11	27.8	3.716304
12	16.0	2.13888	12	28.6	3.823248
13	16.5	2.20572	13	29.4	3.930192
14	17.0	2.27256	14	30.2	4.037136
15	17.5	2.3394	15	31.0	4.14408
16	18.0	2.90624	16	31.8	4.241024
17	18.4	2.459712	17	32.6	4.357968
18	18.8	2.513184	18	33.4	4.464912
19	19.2	2.566656	19	34.2	4.571856
20	19.6	2.620128	20	35.0	4.6788
25	21.5	2.87412	25	38.0	5.07984
30	23.3	3.114744	30	42.0	5.61356
35	24.9	3.328632	35	44.0	5.88192
40	26.3	3.515784	40	46.0	6.14928
45	27.7	3.702936	45	48.0	6.41664
50	29.1	3.890088	50	50.0	6.684
60	32.0	4.27776	60	54.0	7.21872
70	35.0	4.6788	70	58.0	7.75344
80	38.0	5.07984	80	61.2	8.181216
90	41.0	5.48088	90	64.3	8.595624
100	43.5	5.81508	100	67.5	9.0234
120	48.0	6.41664	120	73.0	9.75864
140	52.5	7.0182	140	77.0	10.29336
160	57.0	7.61976	160	81.0	10.82808
180	61.0	8.15448	180	85.5	11.42964
200	65.0	8.6892	200	90.0	12.0312
225	70.0	9.3576	225	95.5	12.76644
250	75.0	10.026	250	101.0	13.50168

(continued)

**TABLE AP103.3(3)—continued
TABLE FOR ESTIMATING DEMAND**

SUPPLY SYSTEMS PREDOMINANTLY FOR FLUSH TANKS			SUPPLY SYSTEMS PREDOMINANTLY FOR FLUSH VALVES		
Load	Demand		Load	Demand	
(Water supply fixture units)	(Gallons per minute)	(Cubic feet per minute)	(Water supply fixture units)	(Gallons per minute)	(Cubic feet per minute)
275	80.0	10.6944	275	104.5	13.96956
300	85.0	11.3628	300	108.0	14.43744
400	105.0	14.0364	400	127.0	16.97736
500	124.0	16.57632	500	143.0	19.11624
750	170.0	22.7256	750	177.0	23.66136
1,000	208.0	27.80544	1,000	208.0	27.80544
1,250	239.0	31.94952	1,250	239.0	31.94952
1,500	269.0	35.95992	1,500	269.0	35.95992
1,750	297.0	39.70296	1,750	297.0	39.70296
2,000	325.0	43.446	2,000	325.0	43.446
2,500	380.0	50.7984	2,500	380.0	50.7984
3,000	433.0	57.88344	3,000	433.0	57.88344
4,000	535.0	70.182	4,000	525.0	70.182
5,000	593.0	79.27224	5,000	593.0	79.27224

**TABLE AP103.3(4)
LOSS OF PRESSURE THROUGH TAPS AND TEES IN POUNDS PER SQUARE INCH (psi)**

GALLONS PER MINUTE	SIZE OF TAP OR TEE (inches)						
	5/8	3/4	1	1 1/4	1 1/2	2	3
10	1.35	0.64	0.18	0.08	—	—	—
20	5.38	2.54	0.77	0.31	0.14	—	—
30	12.10	5.72	1.62	0.69	0.33	0.10	—
40	—	10.20	3.07	1.23	0.58	0.18	—
50	—	15.90	4.49	1.92	0.91	0.28	—
60	—	—	6.46	2.76	1.31	0.40	—
70	—	—	8.79	3.76	1.78	0.55	0.10
80	—	—	11.50	4.90	2.32	0.72	0.13
90	—	—	14.50	6.21	2.94	0.91	0.16
100	—	—	17.94	7.67	3.63	1.12	0.21
120	—	—	25.80	11.00	5.23	1.61	0.30
140	—	—	35.20	15.00	7.12	2.20	0.41
150	—	—	—	17.20	8.16	2.52	0.47
160	—	—	—	19.60	9.30	2.92	0.54
180	—	—	—	24.80	11.80	3.62	0.68
200	—	—	—	30.70	14.50	4.48	0.84
225	—	—	—	38.80	18.40	5.60	1.06
250	—	—	—	47.90	22.70	7.00	1.31
275	—	—	—	—	27.40	7.70	1.59
300	—	—	—	—	32.60	10.10	1.88

For SI: 1 inch = 25.4 mm, 1 pound per square inch = 6.895 kPa, 1 gallon per minute = 3.785 L/m.

TABLE AP103.3(5)
ALLOWANCE IN EQUIVALENT LENGTHS OF PIPE FOR FRICTION LOSS IN VALVES AND THREADED FITTINGS (feet)

FITTING OR VALVE	PIPE SIZE (inches)							
	1/2	3/4	1	1 1/4	1 1/2	2	2 1/2	3
45-degree elbow	1.2	1.5	1.8	2.4	3.0	4.0	5.0	6.0
90-degree elbow	2.0	2.5	3.0	4.0	5.0	7.0	8.0	10.0
Tee, run	0.6	0.8	0.9	1.2	1.5	2.0	2.5	3.0
Tee, branch	3.0	4.0	5.0	6.0	7.0	10.0	12.0	15.0
Gate valve	0.4	0.5	0.6	0.8	1.0	1.3	1.6	2.0
Balancing valve	0.8	1.1	1.5	1.9	2.2	3.0	3.7	4.5
Plug-type cock	0.8	1.1	1.5	1.9	2.2	3.0	3.7	4.5
Check valve, swing	5.6	8.4	11.2	14.0	16.8	22.4	28.0	33.6
Globe valve	15.0	20.0	25.0	35.0	45.0	55.0	65.0	80.0
Angle valve	8.0	12.0	15.0	18.0	22.0	28.0	34.0	40.0

For SI: 1 inch = 25.4 mm, 1 foot = 304.8 mm, 1 degree = 0.0175 rad.

TABLE AP103.3(6)
PRESSURE LOSS IN FITTINGS AND VALVES EXPRESSED AS EQUIVALENT LENGTH OF TUBE^a (feet)

NOMINAL OR STANDARD SIZE (inches)	FITTINGS				Coupling	VALVES			
	Standard Ell		90-Degree Tee			Ball	Gate	Butterfly	Check
	90 Degree	45 Degree	Side Branch	Straight Run					
3/8	0.5	—	1.5	—	—	—	—	—	1.5
1/2	1	0.5	2	—	—	—	—	—	2
5/8	1.5	0.5	2	—	—	—	—	—	2.5
3/4	2	0.5	3	—	—	—	—	—	3
1	2.5	1	4.5	—	—	0.5	—	—	4.5
1 1/4	3	1	5.5	0.5	0.5	0.5	—	—	5.5
1 1/2	4	1.5	7	0.5	0.5	0.5	—	—	6.5
2	5.5	2	9	0.5	0.5	0.5	0.5	7.5	9
2 1/2	7	2.5	12	0.5	0.5	—	1	10	11.5
3	9	3.5	15	1	1	—	1.5	15.5	14.5
3 1/2	9	3.5	14	1	1	—	2	—	12.5
4	12.5	5	21	1	1	—	2	16	18.5
5	16	6	27	1.5	1.5	—	3	11.5	23.5
6	19	7	34	2	2	—	3.5	13.5	26.5
8	29	11	50	3	3	—	5	12.5	39

For SI: 1 inch = 25.4 mm, 1 foot = 304.8 mm, 1 degree = 0.01745 rad.

a. Allowances are for streamlined soldered fittings and recessed threaded fittings. For threaded fittings, double the allowances shown in the table. The equivalent lengths presented above are based on a C factor of 150 in the Hazen-Williams friction loss formula. The lengths shown are rounded to the nearest half-foot.

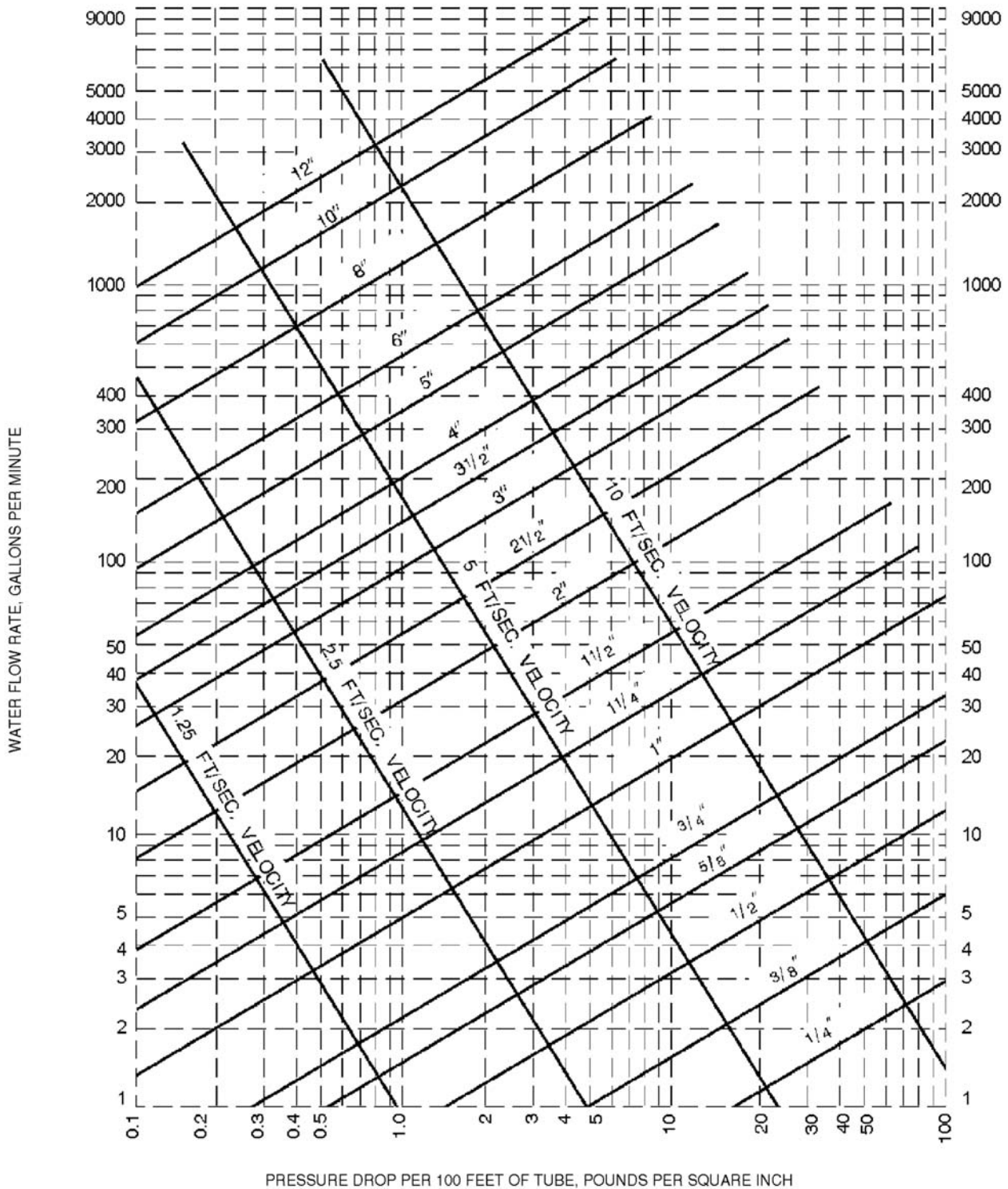

Note: Fluid velocities in excess of 5 to 8 feet/second are not usually recommended.

**FIGURE AP103.3(2)
FRICTION LOSS IN SMOOTH PIPE^a (TYPE K, ASTM B 88 COPPER TUBING)**

For SI: 1 inch = 25.4 mm, 1 foot = 304.8 mm, 1 gpm = 3.785 L/m, 1 psi = 6.895 kPa, 1 foot per second = 0.305 m/s.

a. This chart applies to smooth new copper tubing with recessed (streamline) soldered joints and to the actual sizes of types indicated on the diagram.

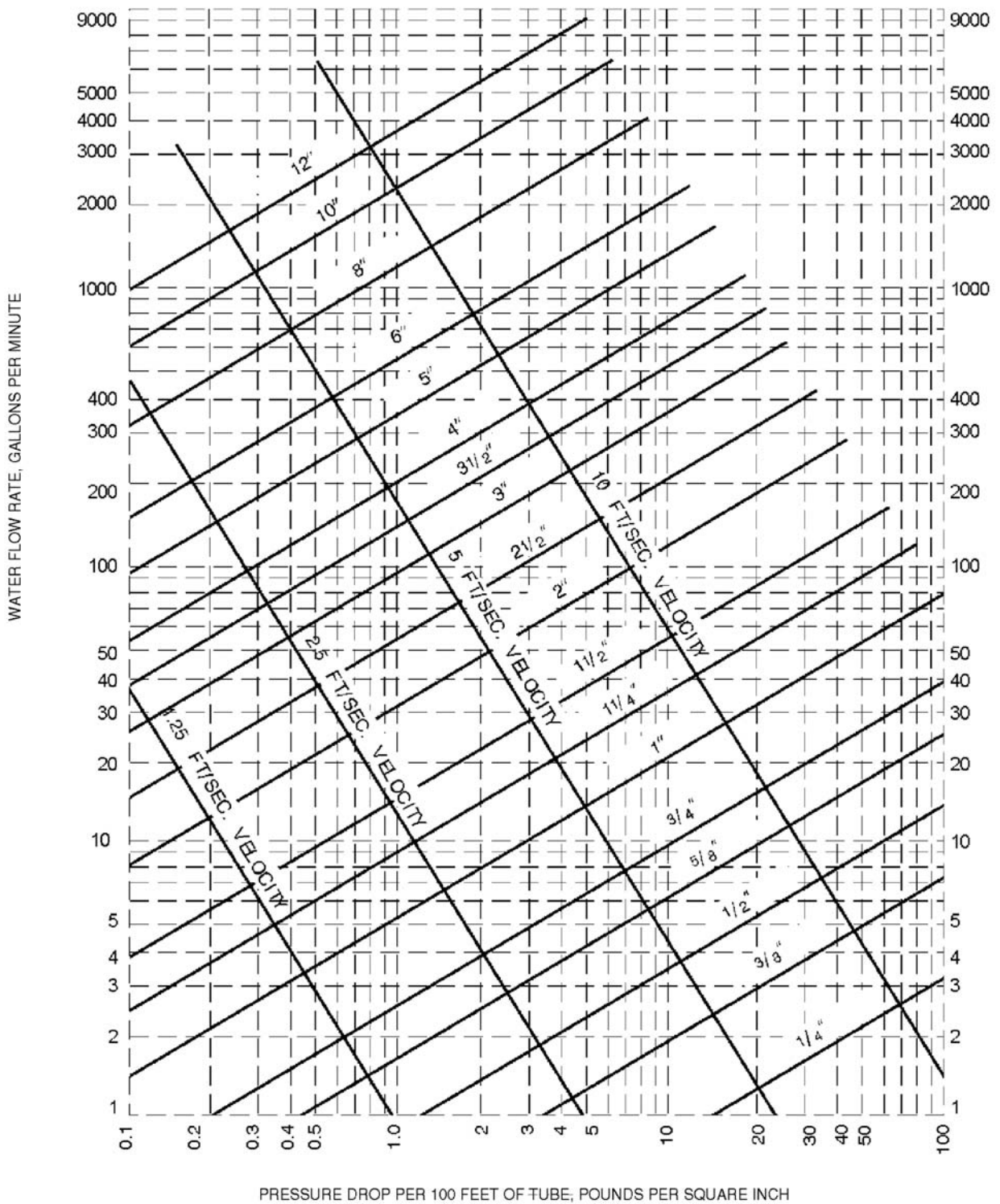

Note: Fluid velocities in excess of 5 to 8 feet/second are not usually recommended.

FIGURE AP103.3(3)
FRICTION LOSS IN SMOOTH PIPE^a (TYPE L, ASTM B 88 COPPER TUBING)

For SI: 1 inch = 25.4 mm, 1 foot = 304.8 mm, 1 gpm = 3.785 L/m, 1 psi = 6.895 kPa, 1 foot per second = 0.305 m/s.

a. This chart applies to smooth new copper tubing with recessed (streamline) soldered joints and to the actual sizes of types indicated on the diagram.

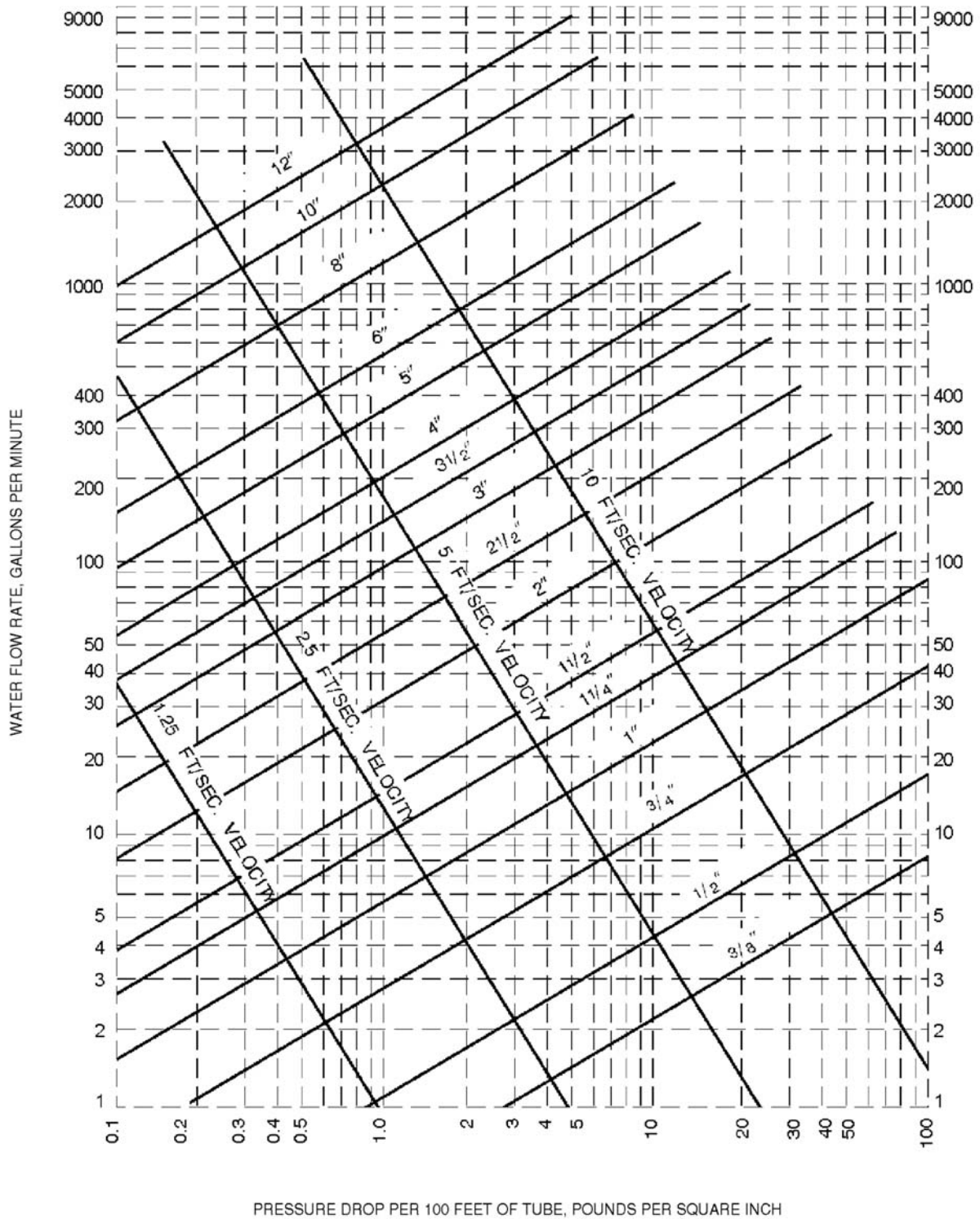

Note: Fluid velocities in excess of 5 to 8 feet/second are not usually recommended.

FIGURE AP103.3(4)
FRICTION LOSS IN SMOOTH PIPE^a (TYPE M, ASTM B 88 COPPER TUBING)

For SI: 1 inch = 25.4 mm, 1 foot = 304.8 mm, 1 gpm = 3.785 L/m, 1 psi = 6.895 kPa, 1 foot per second = 0.305 m/s.

a. This chart applies to smooth new copper tubing with recessed (streamline) soldered joints and to the actual sizes of types indicated on the diagram.

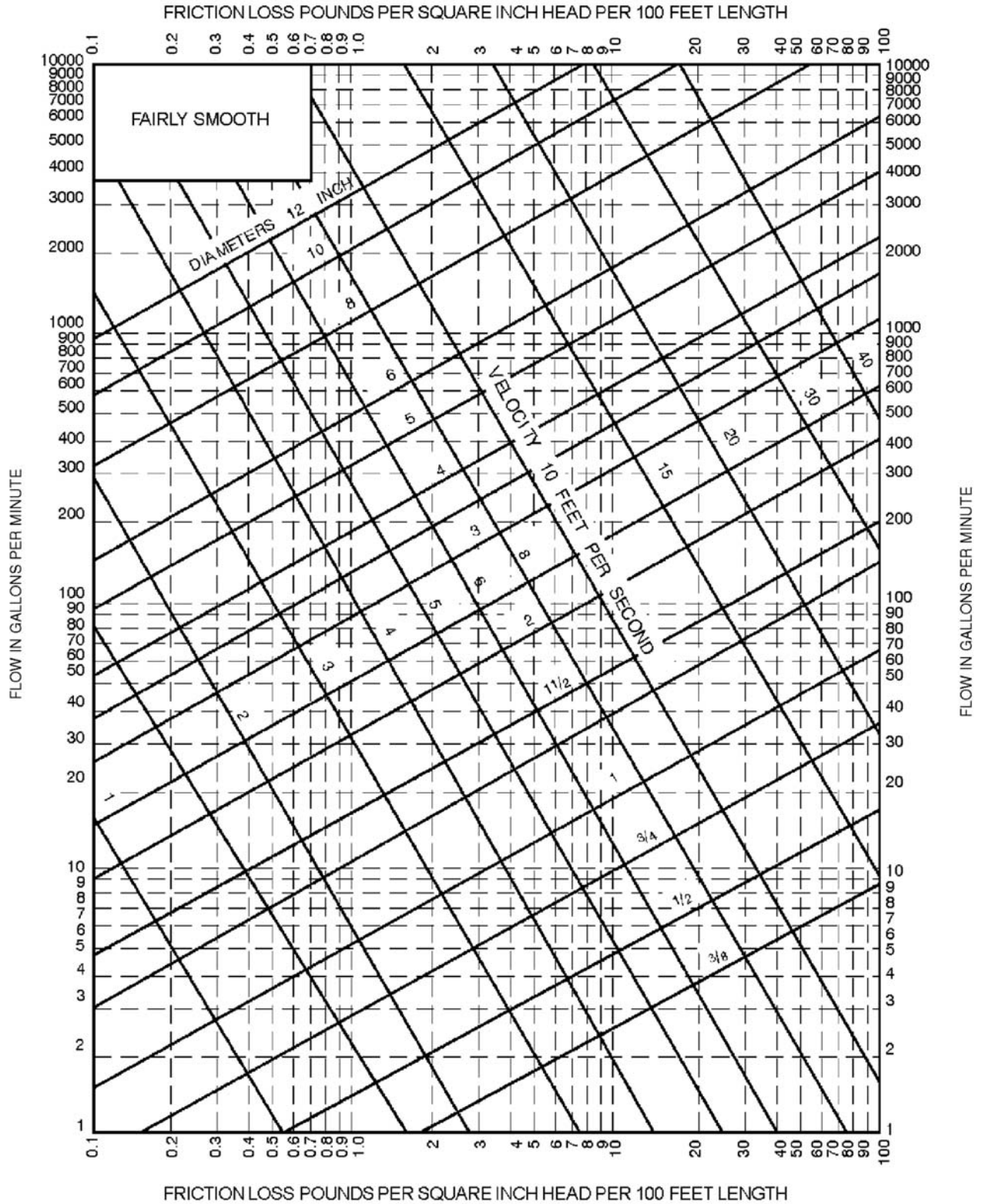

**FIGURE AP103.3(5)
FRICITION LOSS IN FAIRLY SMOOTH PIPE^a**

For SI: 1 inch = 25.4 mm, 1 foot = 304.8 mm, 1 gpm = 3.785 L/m, 1 psi = 6.895 kPa, 1 foot per second = 0.305 m/s.

a. This chart applies to smooth new steel (fairly smooth) pipe and to actual diameters of standard-weight pipe.

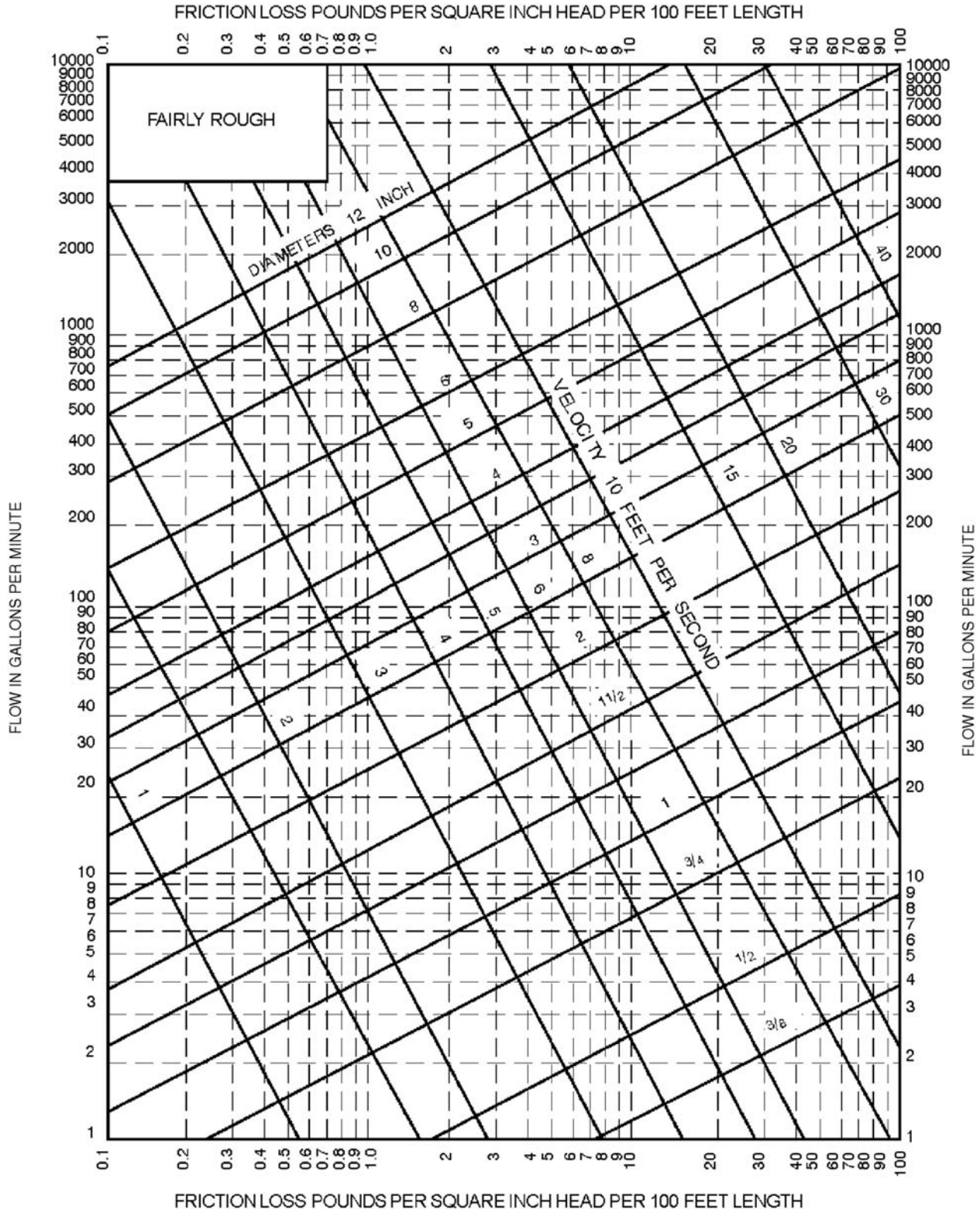

FIGURE AP103.3(6)
FRICTION LOSS IN FAIRLY ROUGH PIPE^a

For SI: 1 inch = 25.4 mm, 1 foot = 304.8 mm, 1 gpm = 3.785 L/m, 1 psi = 6.895 kPa, 1 foot per second = 0.305 m/s.

a. This chart applies to fairly rough pipe and to actual diameters which in general will be less than the actual diameters of the new pipe of the same kind.

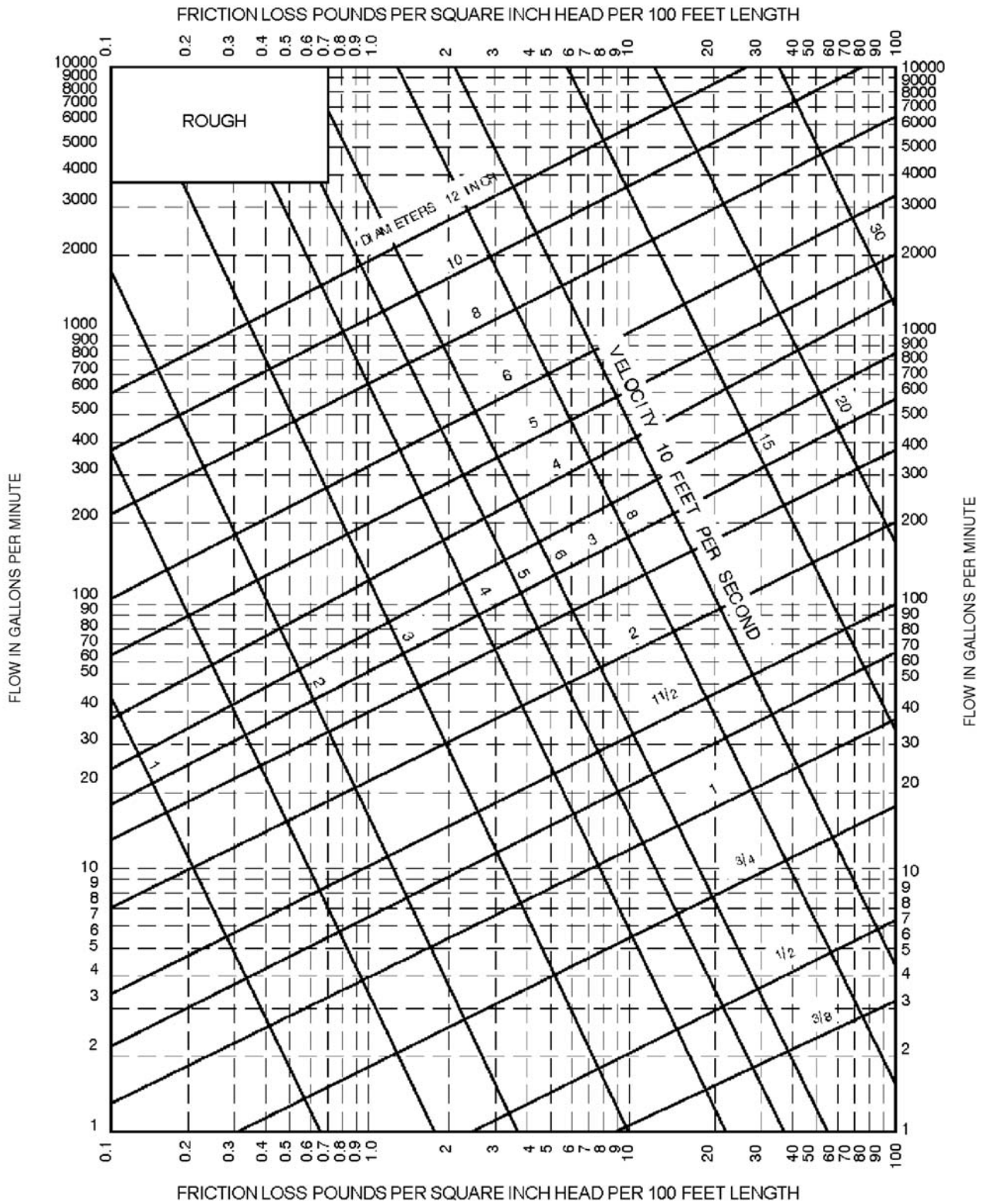

FIGURE AP103.3(7)
FRICITION LOSS IN FAIRLY ROUGH PIPE^a

For SI: 1 inch = 25.4 mm, 1 foot = 304.8 mm, 1 gpm = 3.785 L/m, 1 psi = 6.895 kPa, 1 foot per second = 0.305 m/s.

a. This chart applies to very rough pipe and existing pipe and to their actual diameters.

SECTION AP201 SELECTION OF PIPE SIZE

AP201.1 Size of water-service mains, branch mains and risers. The minimum size water service pipe shall be $\frac{3}{4}$ inch (19.1 mm). The size of water service mains, branch mains and risers shall be determined according to water supply demand [gpm (L/m)], available water pressure [psi (kPa)] and friction loss caused by the water meter and *developed length* of pipe [feet (m)], including *equivalent length* of fittings. The size of each water distribution system shall be determined according to the procedure outlined in this section or by other design methods conforming to acceptable engineering practice and *approved* by the code official:

1. Supply load in the building water-distribution system shall be determined by total load on the pipe being sized, in terms of water-supply fixture units (w.s.f.u.), as shown in Table AP103.3(2). For fixtures not listed, choose a w.s.f.u. value of a fixture with similar flow characteristics.
2. Obtain the minimum daily static service pressure [psi (kPa)] available (as determined by the local water authority) at the water meter or other source of supply at the installation location. Adjust this minimum daily static pressure [psi (kPa)] for the following conditions:
 - 2.1. Determine the difference in elevation between the source of supply and the highest water supply outlet. Where the highest water supply outlet is located above the source of supply, deduct 0.5 psi (3.4 kPa) for each foot (0.3 m) of difference in elevation. Where the highest water supply outlet is located below the source of supply, add 0.5 psi (3.4 kPa) for each foot (0.3 m) of difference in elevation.
 - 2.2. Where a water pressure reducing valve is installed in the water distribution system, the minimum daily static water pressure available is 80 percent of the minimum daily static water pressure at the source of supply or the set pressure downstream of the pressure reducing valve, whichever is smaller.
 - 2.3. Deduct all pressure losses caused by special equipment such as a backflow preventer, water filter and water softener. Pressure loss data for each piece of equipment shall be obtained through the manufacturer of the device.
 - 2.4. Deduct the pressure in excess of 8 psi (55 kPa) resulting from installation of the special plumbing fixture, such as temperature-controlled shower and flushometer tank water closet. Using the resulting minimum available pressure, find the corresponding pressure range in Table AP201.1.
3. The maximum *developed length* for water piping is the actual length of pipe between the source of supply and the most remote fixture, including either hot (through the water heater) or cold water branches multiplied by a factor of 1.2 to compensate for pressure loss through fittings. Select the appropriate column in Table AP201.1 equal to or greater than the calculated maximum *developed length*.
4. To determine the size of water service pipe, meter and main distribution pipe to the building using the appropriate table, follow down the selected “maximum *developed length*” column to a fixture unit equal to or greater than the total installation demand calculated by using the “combined” water supply fixture unit column of Table AP201.1. Read the water service pipe and meter sizes in the first left-hand column and the main distribution pipe to the building in the second left-hand column on the same row.
5. To determine the size of each water distribution pipe, start at the most remote outlet on each branch (either hot or cold branch) and, working back toward the main distribution pipe to the building, add up the water supply fixture unit demand passing through each segment of the distribution system using the related hot or cold column of Table AP201.1. Knowing demand, the size of each segment shall be read from the second left-hand column of the same table and maximum *developed length* column selected in Steps 1 and 2, under the same or next smaller size meter row. In no case does the size of any branch or main need to be larger than the size of the main distribution pipe to the building established in Step 4.

**TABLE AP201.1
MINIMUM SIZE OF WATER METERS, MAINS AND DISTRIBUTION PIPING
BASED ON WATER SUPPLY FIXTURE UNIT VALUES (w.s.f.u.)**

METER AND SERVICE PIPE (inches)	DISTRIBUTION PIPE (inches)	MAXIMUM DEVELOPMENT LENGTH (feet)										
		40	60	80	100	150	200	250	300	400	500	
Pressure Range 30 to 39 psi												
3/4	1/2 ^a	2.5	2	1.5	1.5	1	1	0.5	0.5	0	0	
3/4	3/4	9.5	7.5	6	5.5	4	3.5	3	2.5	2	1.5	
3/4	1	32	25	20	16.5	11	9	7.8	6.5	5.5	4.5	
1	1	32	32	27	21	13.5	10	8	7	5.5	5	
3/4	1 1/4	32	32	32	32	30	24	20	17	13	10.5	
1	1 1/4	80	80	70	61	45	34	27	22	16	12	
1 1/2	1 1/4	80	80	80	75	54	40	31	25	17.5	13	
1	1 1/2	87	87	87	87	84	73	64	56	45	36	
1 1/2	1 1/2	151	151	151	151	117	92	79	69	54	43	
2	1 1/2	151	151	151	151	128	99	83	72	56	45	
1	2	87	87	87	87	87	87	87	87	87	86	
1 1/2	2	275	275	275	275	258	223	196	174	144	122	
2	2	365	365	365	365	318	266	229	201	160	134	
2	2 1/2	533	533	533	533	533	495	448	409	353	311	

METER AND SERVICE PIPE (inches)	DISTRIBUTION PIPE (inches)	MAXIMUM DEVELOPMENT LENGTH (feet)										
		40	60	80	100	150	200	250	300	400	500	
Pressure Range 40 to 49 psi												
3/4	1/2 ^a	3	2.5	2	1.5	1.5	1	1	0.5	0.5	0.5	
3/4	3/4	9.5	9.5	8.5	7	5.5	4.5	3.5	3	2.5	2	
3/4	1	32	32	32	26	18	13.5	10.5	9	7.5	6	
1	1	32	32	32	32	21	15	11.5	9.5	7.5	6.5	
3/4	1 1/4	32	32	32	32	32	32	32	27	21	16.5	
1	1 1/4	80	80	80	80	65	52	42	35	26	20	
1 1/2	1 1/4	80	80	80	80	75	59	48	39	28	21	
1	1 1/2	87	87	87	87	87	87	87	78	65	55	
1 1/2	1 1/2	151	151	151	151	151	130	109	93	75	63	
2	1 1/2	151	151	151	151	151	139	115	98	77	64	
1	2	87	87	87	87	87	87	87	87	87	87	
1 1/2	2	275	275	275	275	275	275	264	238	198	169	
2	2	365	365	365	365	365	349	304	270	220	185	
2	2 1/2	533	533	533	533	533	533	533	528	456	403	

(continued)

**TABLE AP201.1—continued
MINIMUM SIZE OF WATER METERS, MAINS AND DISTRIBUTION PIPING
BASED ON WATER SUPPLY FIXTURE UNIT VALUES (w.s.f.u.)**

METER AND SERVICE PIPE (inches)	DISTRIBUTION PIPE (inches)	MAXIMUM DEVELOPMENT LENGTH (feet)										
		40	60	80	100	150	200	250	300	400	500	
Pressure Range 50 to 60 psi												
3/4	1/2 ^a	3	3	2.5	2	1.5	1	1	1	0.5	0.5	
3/4	3/4	9.5	9.5	9.5	8.5	6.5	5	4.5	4	3	2.5	
3/4	1	32	32	32	32	25	18.5	14.5	12	9.5	8	
1	1	32	32	32	32	30	22	16.5	13	10	8	
3/4	1 1/4	32	32	32	32	32	32	32	32	29	24	
1	1 1/4	80	80	80	80	80	68	57	48	35	28	
1 1/2	1 1/4	80	80	80	80	80	75	63	53	39	29	
1	1 1/2	87	87	87	87	87	87	87	87	82	70	
1 1/2	1 1/2	151	151	151	151	151	151	139	120	94	79	
2	1 1/2	151	151	151	151	151	151	146	126	97	81	
1	2	87	87	87	87	87	87	87	87	87	87	
1 1/2	2	275	275	275	275	275	275	275	275	247	213	
2	2	365	365	365	365	365	365	365	329	272	232	
2	2 1/2	533	533	533	533	533	533	533	533	533	486	

METER AND SERVICE PIPE (inches)	DISTRIBUTION PIPE (inches)	MAXIMUM DEVELOPMENT LENGTH (feet)										
		40	60	80	100	150	200	250	300	400	500	
Pressure Range Over 60												
3/4	1/2 ^a	3	3	3	2.5	2	1.5	1.5	1	1	0.5	
3/4	3/4	9.5	9.5	9.5	9.5	7.5	6	5	4.5	3.5	3	
3/4	1	32	32	32	32	32	24	19.5	15.5	11.5	9.5	
1	1	32	32	32	32	32	28	28	17	12	9.5	
3/4	1 1/4	32	32	32	32	32	32	32	32	32	30	
1	1 1/4	80	80	80	80	80	80	69	60	46	36	
1 1/2	1 1/4	80	80	80	80	80	80	76	65	50	38	
1	1 1/2	87	87	87	87	87	87	87	87	87	84	
1 1/2	1 1/2	151	151	151	151	151	151	151	144	114	94	
2	1 1/2	151	151	151	151	151	151	151	151	118	97	
1	2	87	87	87	87	87	87	87	87	87	87	
1 1/2	2	275	275	275	275	275	275	275	275	275	252	
2	2	365	368	368	368	368	368	368	368	318	273	
2	2 1/2	533	533	533	533	533	533	533	533	533	533	

For SI: 1 inch = 25.4, 1 foot = 304.8 mm.

a. Minimum size for building supply is 3/4-inch pipe.